

Domová vodomerná šachta 2-dielna

Tvar:

REZ A - A

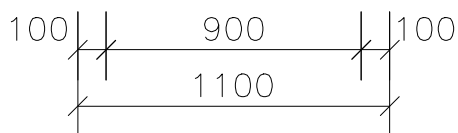
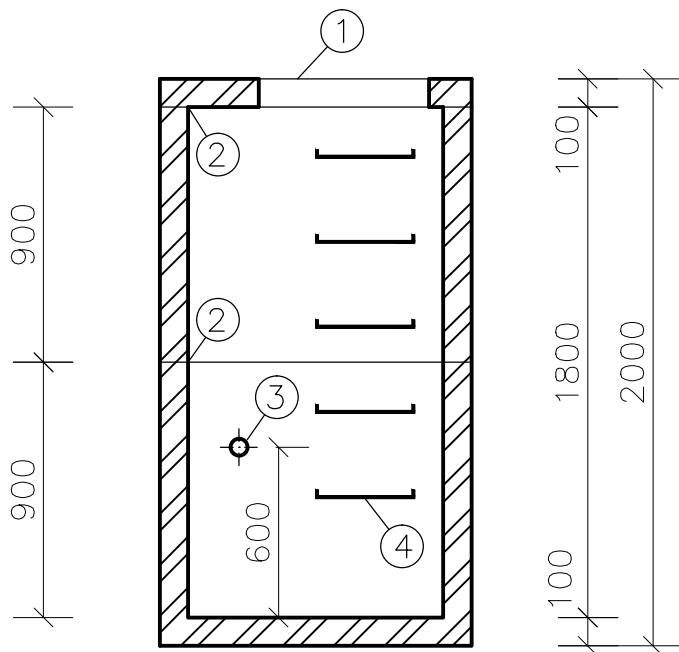

PÔDORYS

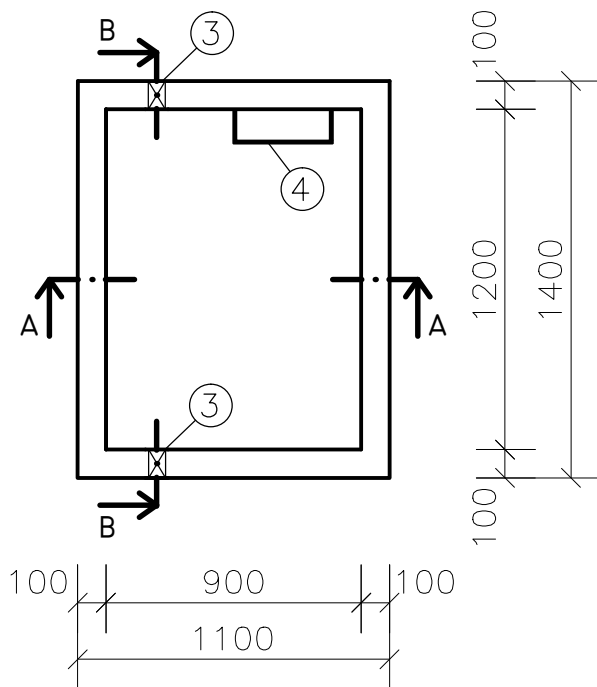

Domová vodomerná šachta 2-dielna

Tvar:

REZ B - B

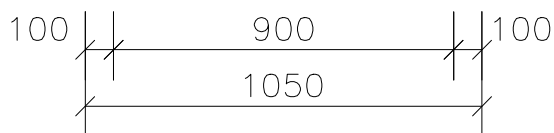
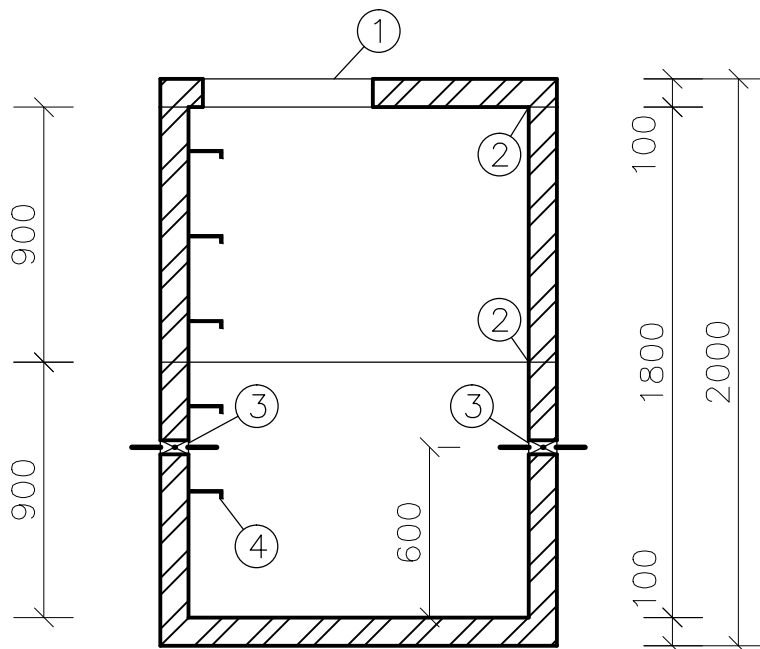

PÔDORYS

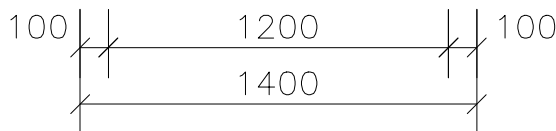
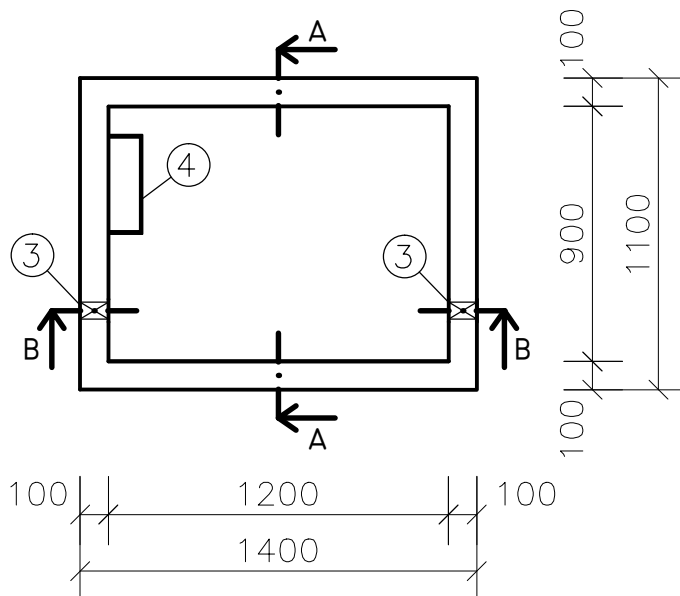

Stropná doska k vodomernej šachte hr. 100 mm

Tvar:

REZ

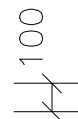
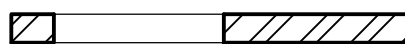

PÔDORYS

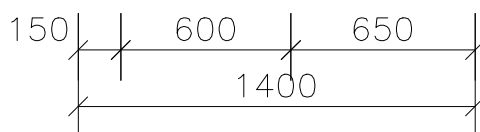
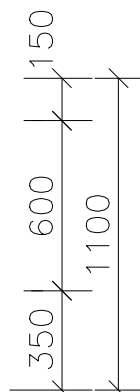
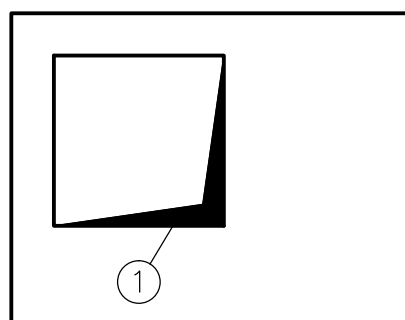

Technické údaje:

Hmotnosť:	Dno	1420 kg
	Driek	1035 kg
	Strop 100 mm	330 kg
	Spolu	2785 kg

Betón: C20/25

LEGENDA:

- ① Vstup do vodomernej šachty, otvor 600/600 mm
- ② Tupý spoj vyplnený montážnou penou
- ③ Otvor DN 63 mm na vodovodné potrubie
- ④ Poplastované stúpadlo