

Prechodová doska hr.180 mm

Technické údaje:

Rozmery: \varnothing 1200/180 mm

Hmotnosť: 384 kg

Betón: C25/30

Tvar:

REZ

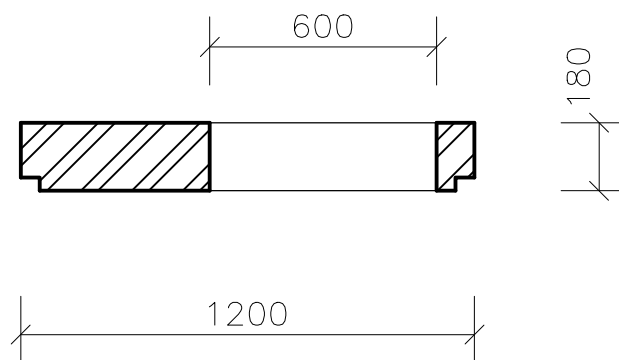

PÔDORYS

